

Testing of Single Photon Avalanche Diode Cameras for pressure- sensitive paint measurements

Dimitrios Tsioumanis
The University of Manchester

Testing of Single Photon Avalanche Diode Cameras for pressure-sensitive paint measurements

Dimitrios Tsioumanis*, **Mark K Quinn***, **Paul J White^**, **Jonathan PJ Stevenson^**, **Luca Battaglia^**

***University of Manchester, ^Airbus Operations UK**

National Wind Tunnel Facility Conference, 02-03 April 2025

The Exchange, University of Birmingham, UK



The University of Manchester



- A quantitative pressure measurement technique.
- Data gathered over a surface compared to point data of traditional pressure taps.
- Uses the principles of photoluminescence and oxygen quenching.
 - The amount of light depends on the partial pressure of oxygen.

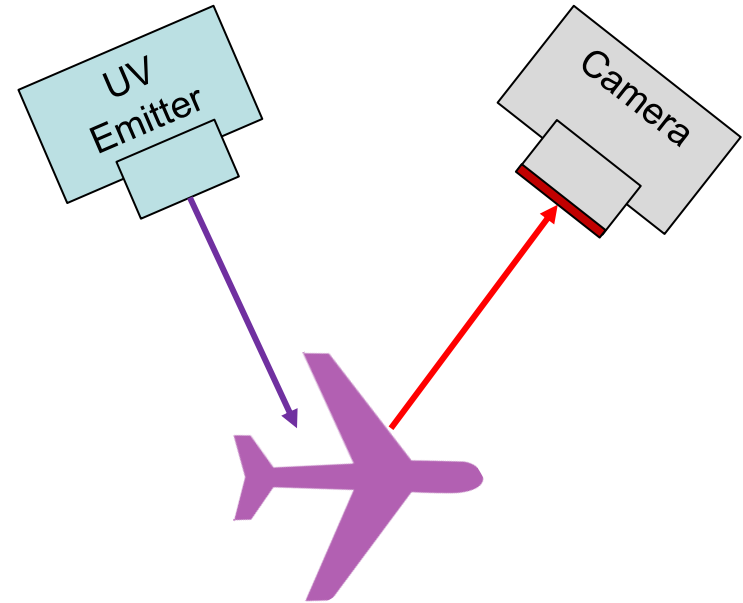

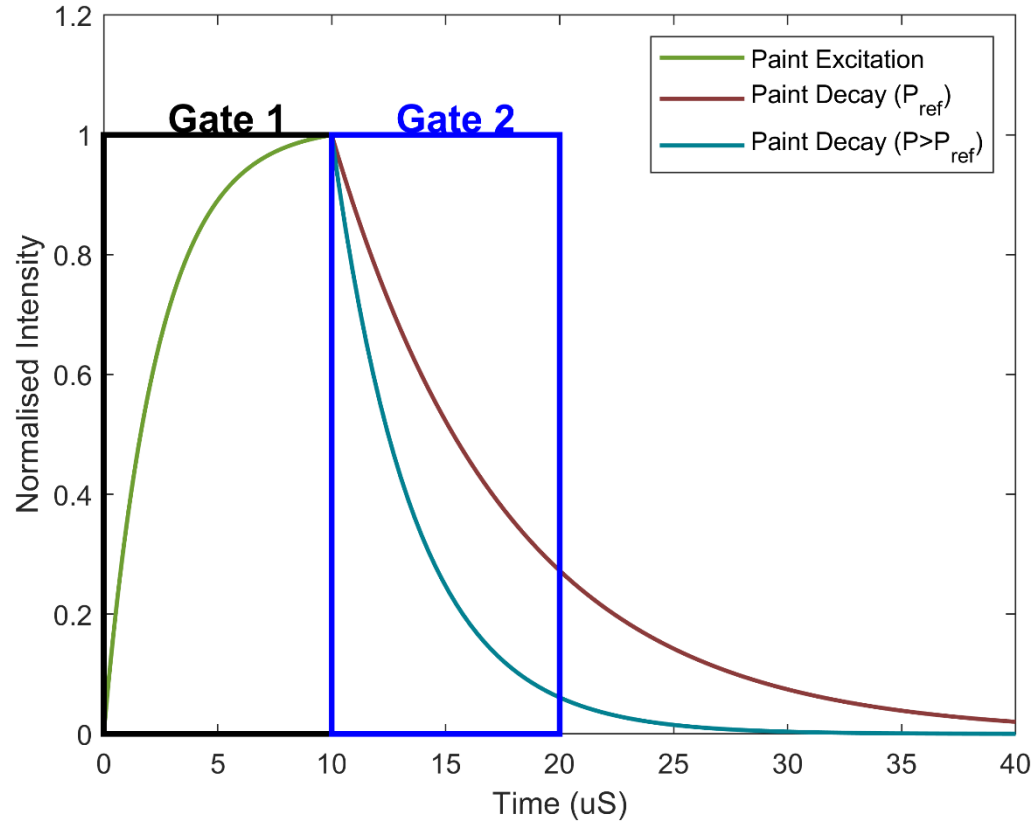

**approx. 1X
multiplication**

Due to the impact of noise, may not be able to detect a single photon, leading to degraded accuracy.

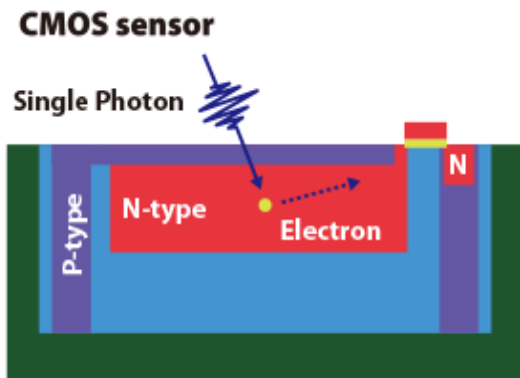

**approx. 1000000X
multiplication**

Correctly detect an incident of single photon. Detection of an individual photon without noise increases the accuracy of information.

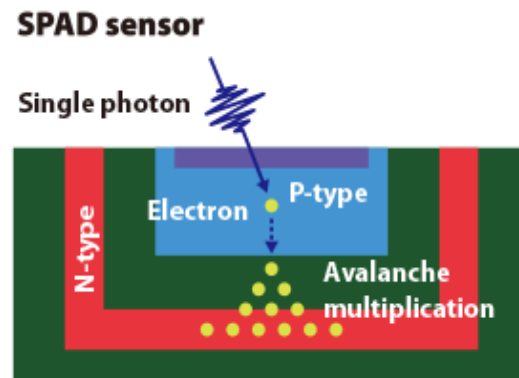

1-bit to n-bit images

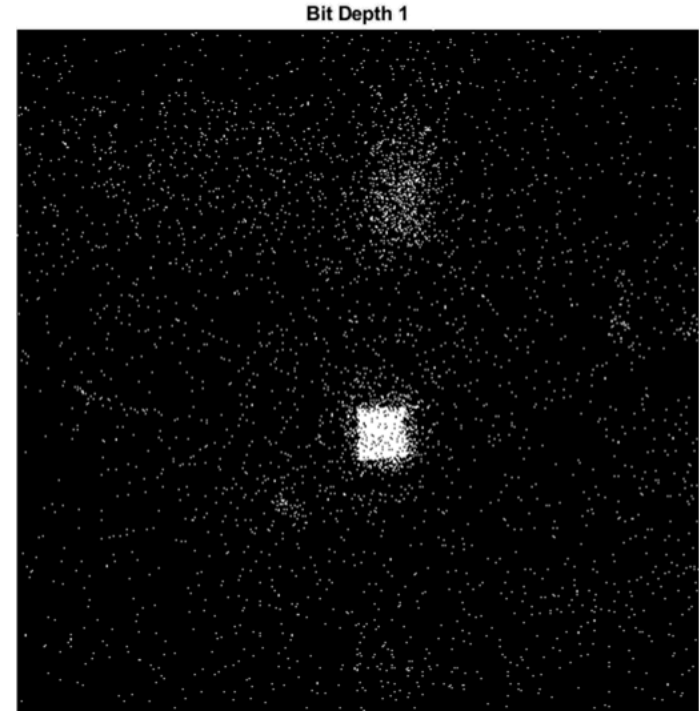
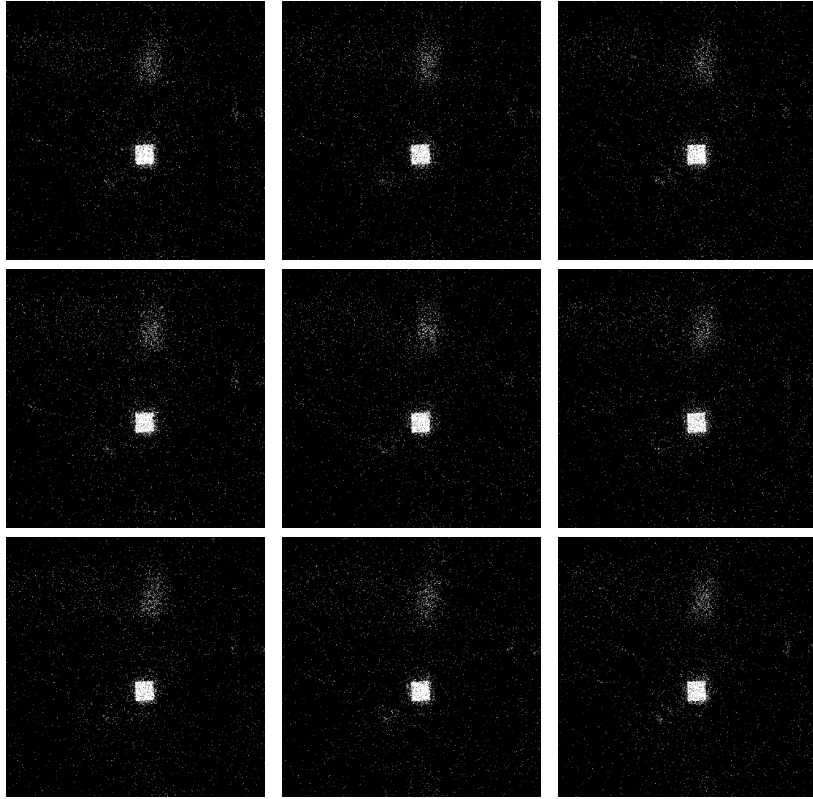

- In-house calibration chamber.
- TEC-1091 PID temperature controller.
- DRUCK PACE5000 pressure controller.
- PCO.2000 & SPAD 512² cameras.
- Luminus Devices CBM-120-UV with custom overdrive circuit for lifetime
- ISSI 2-Inch UV LED Lamp for intensity
- Temperature settings: 273K, 288K, 303K.
- Pressure range: 20-200kPa in 10kPa increments.

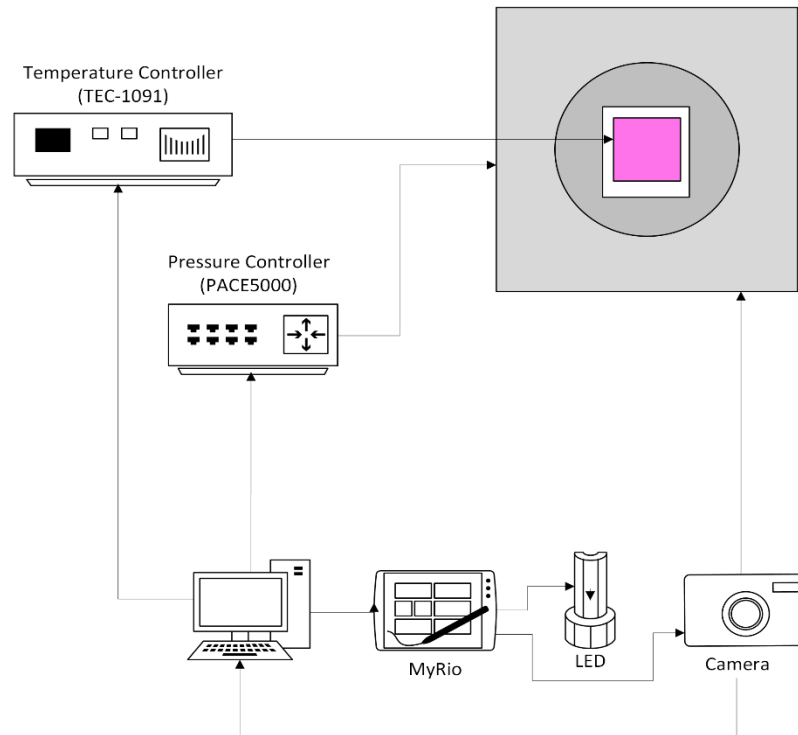

Intensity

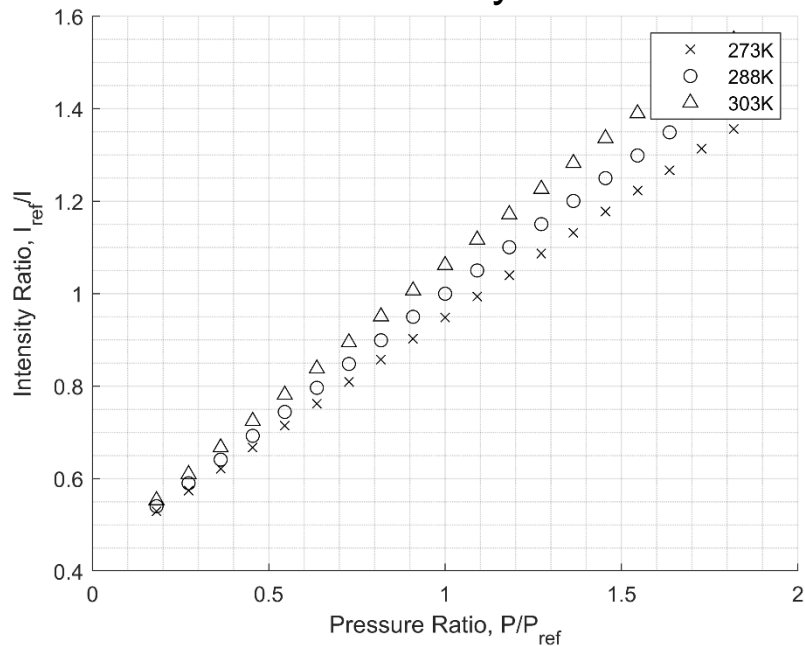

Lifetime

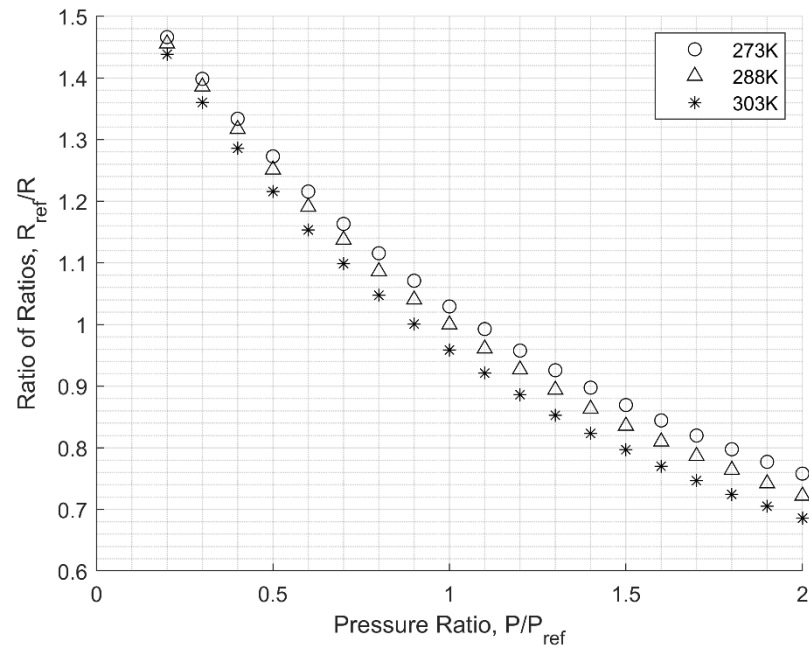

Pressure sensitivity

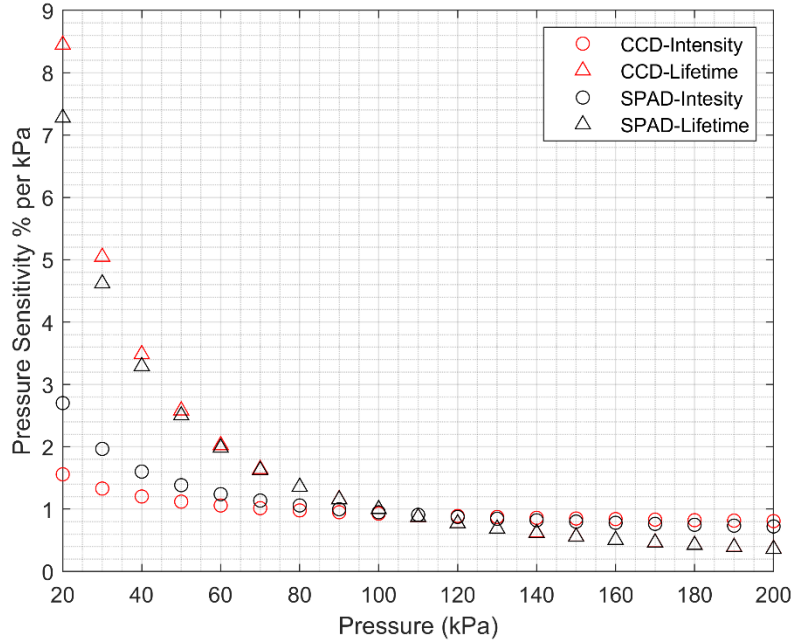

Temperature sensitivity

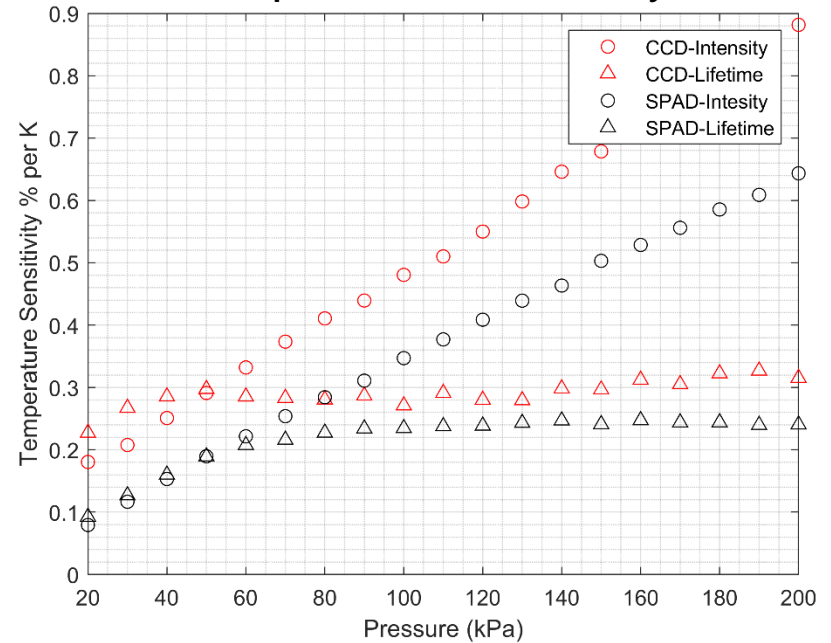

Measured points along curve

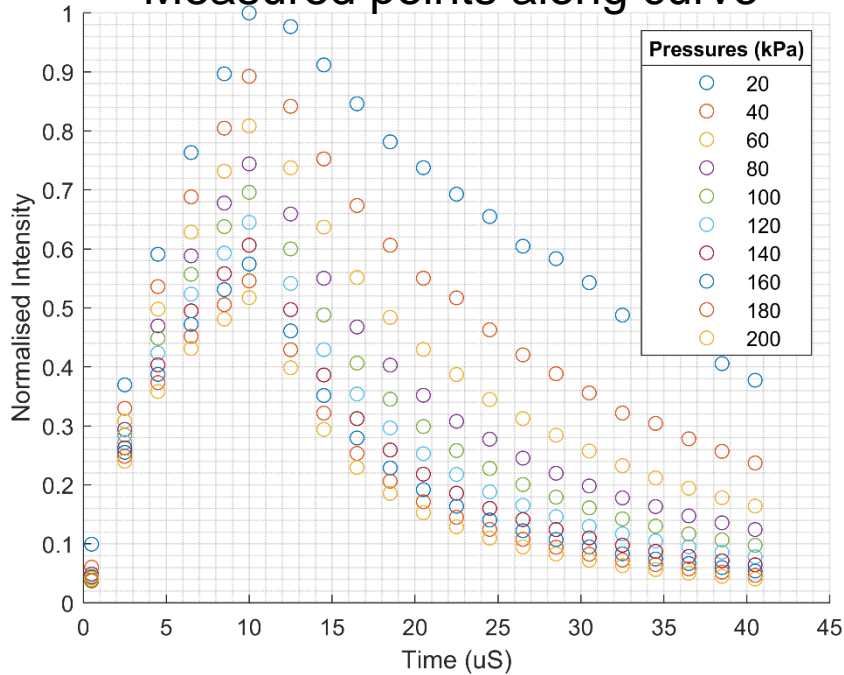

Ratio of ratios of lifetime

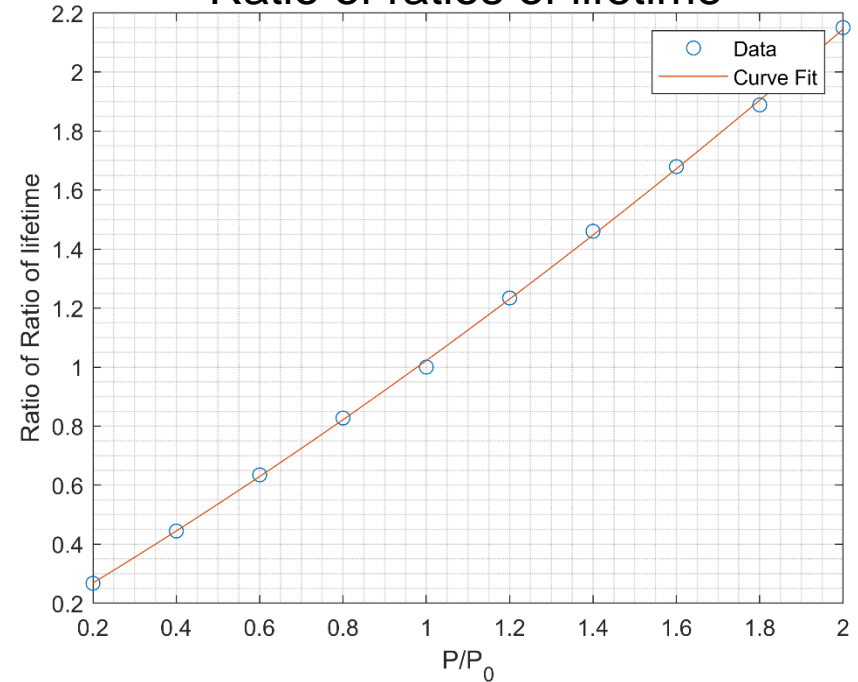

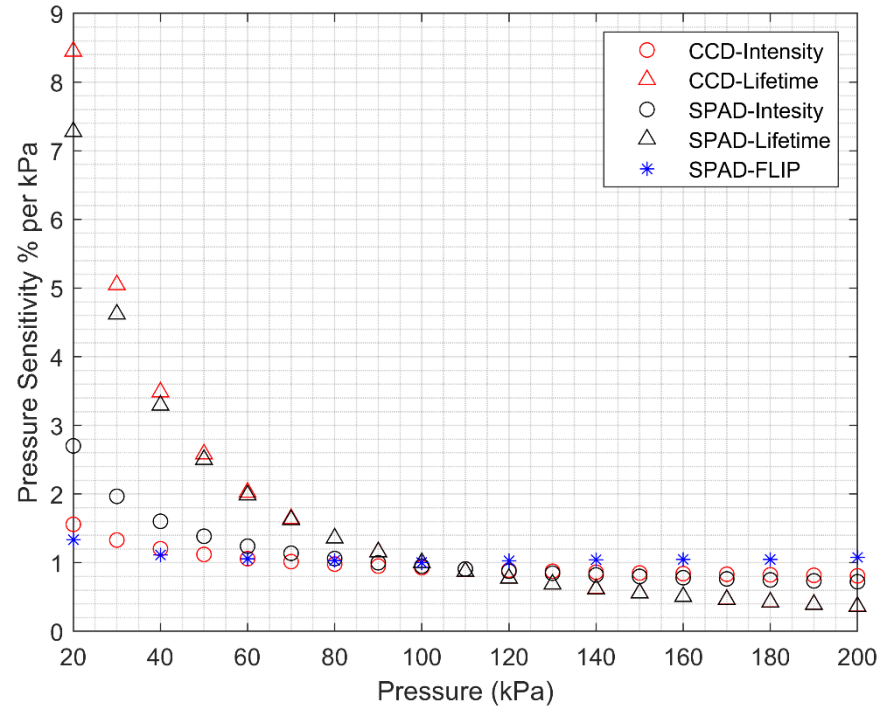

- Preliminary calibrations show that the SPAD sensor is a suitable, modern replacement for PSP measurements.
- Future Work
 - Wind tunnel testing at Filton and at the University of Manchester.
 - Detailed FLI-PSP calibrations and uncertainty Analysis

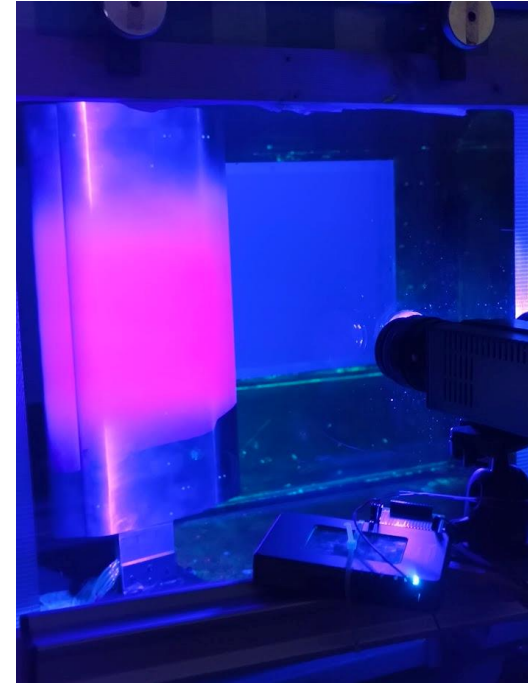

- Thank you to Airbus Operations UK for their financial and technical support
- Thank you to the technical staff at the university of Manchester for their support.
- Thank you to Pi Imaging for their technical support.

- Any Questions?

Temperature Sensitivity

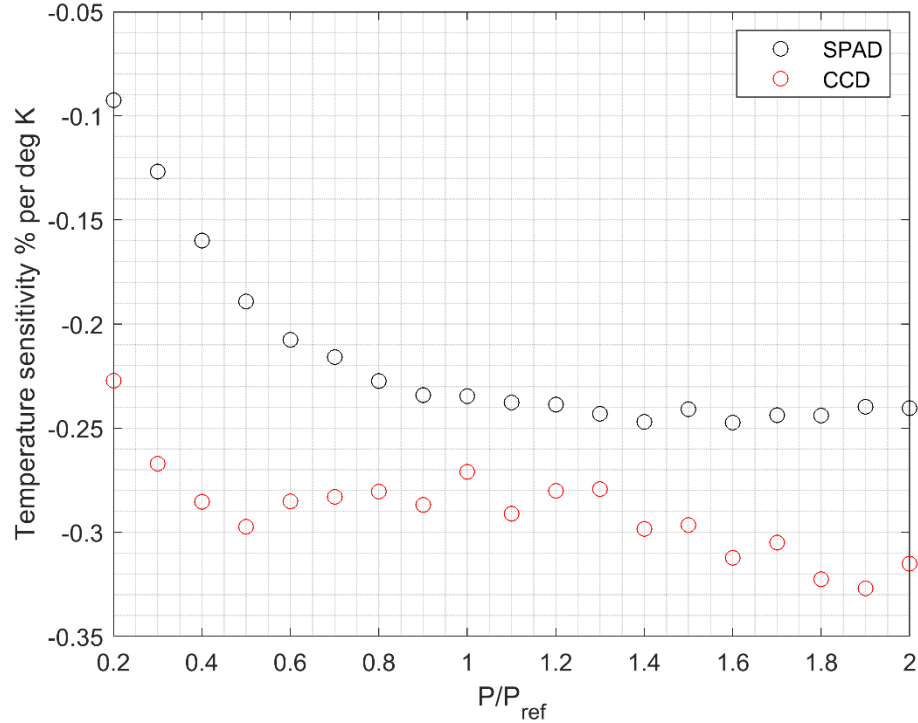

Pressure Sensitivity

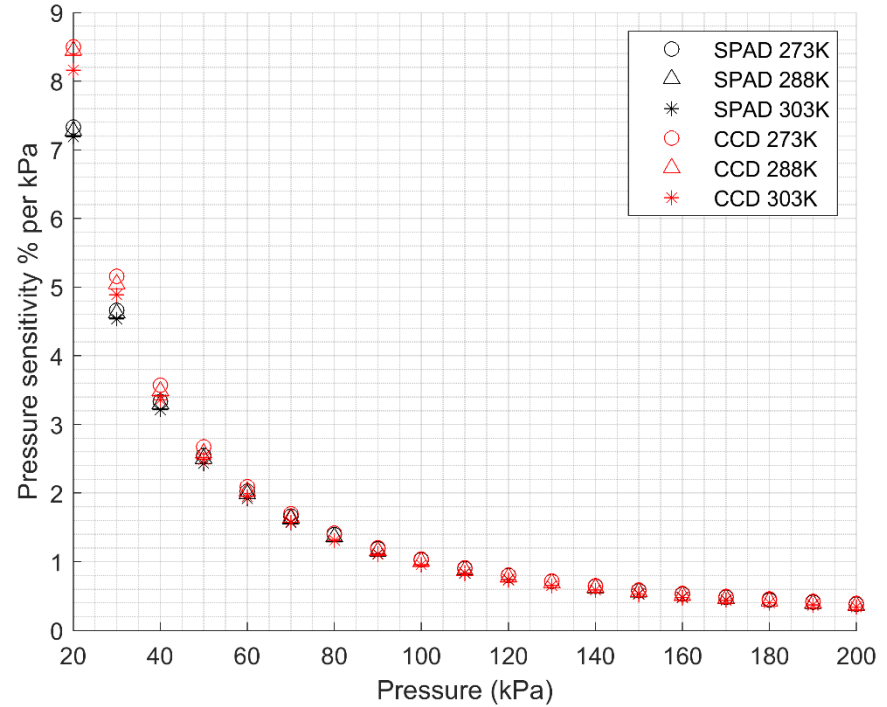

Temperature Sensitivity

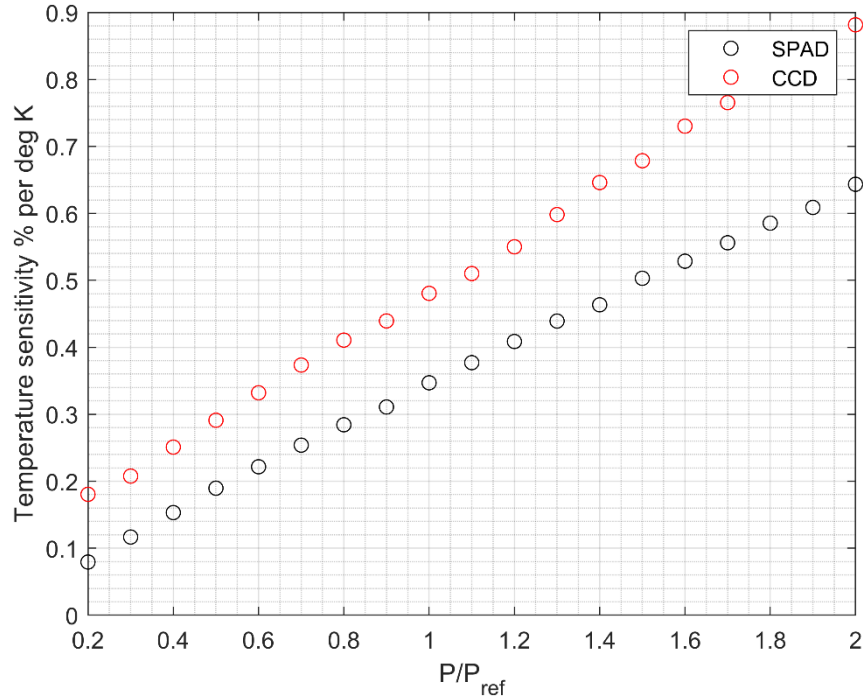

Pressure Sensitivity

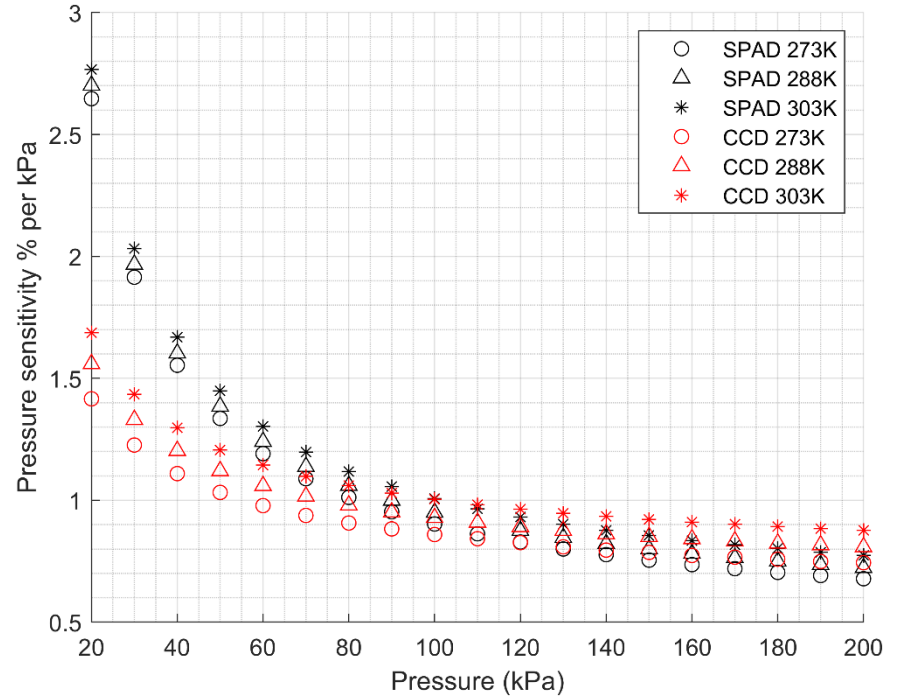

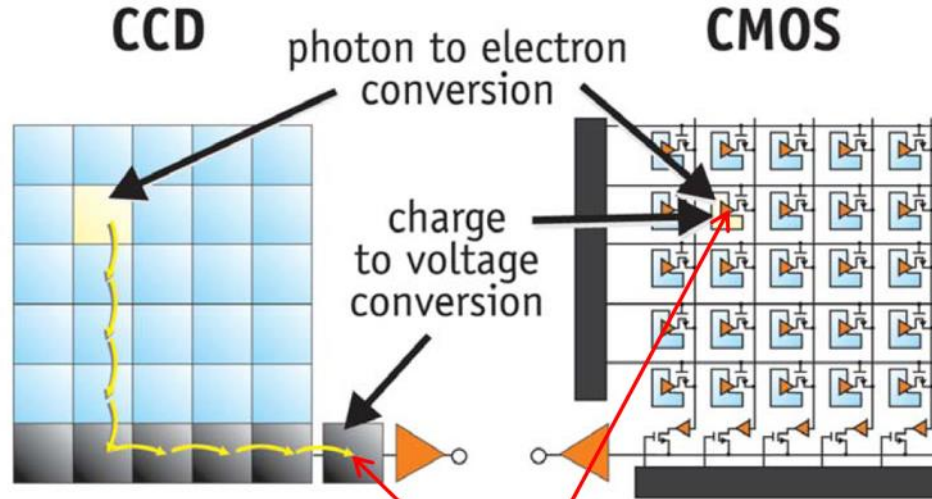

CCDs move photogenerated charge from pixel to pixel and convert it to voltage at an output node. CMOS imagers convert charge to voltage inside each pixel.

Read-out noise generated



